



---

TECHNICAL REFERENCE

# Oracle Data Management with Rubrik

June 2020

---

# TABLE OF CONTENTS

## **3 AUDIENCE**

## **3 EXECUTIVE SUMMARY**

## **4 CUSTOMER CHALLENGES**

- 4 Maintaining and Managing Existing Backups
- 4 Balancing database performance and protection
- 4 Serving the needs of secondary users
- 4 The divide between DBAs and Backup Administrators

## **5 KEY CAPABILITIES IN RUBRIK FOR ORACLE DATABASE**

- 5 Automated Oracle Data Protection
- 5 True incremental forever backups
- 5 Rubrik Live Mount

## **5 INTRODUCTION TO RUBRIK CDM CONCEPTS**

- 5 SLA Domain Policy
- 7 Reports
- 7 Role-Based Access

## **8 AUTOMATED ORACLE DATA MANAGEMENT WITH RUBRIK**

- 8 Protecting Oracle Databases
  - 8 Setup
  - 9 Auto Discovery
  - 10 SLA Domain Assignment
  - 11 Oracle Backup Workflow
- 12 Restoring Oracle Databases with Rubrik
  - 13 Clone
    - Automated Clone
    - DBA Managed Clone
    - Tablespace Clones
  - 15 Instant Recovery
  - 16 Live Mount
  - 17 Recover Production

## **17 CONCLUSION**

## AUDIENCE

This technical reference is intended for architects and administrators designing data protection, copy data orchestration, and compliance solutions for Oracle databases. This paper will provide a feature walkthrough with relevant use cases on how Rubrik Cloud Data Management may be used for protecting Oracle databases running on physical systems and virtual machines.

## EXECUTIVE SUMMARY

Oracle databases are often the driving force behind an organization's most critical applications - providing a performance driven, relational storage for key transactions. For this reason, businesses cannot afford downtime when it comes to their Oracle database environments.

Rubrik Cloud Data Management (CDM) delivers enterprise grade data protection and DevOps centric automation for Oracle databases. For those organizations looking for a simple, hands off approach to Oracle protection, Rubrik provides Automated Oracle Data Protection. This allows for automatic discovery of Oracle databases to be coupled with the simplicity of Rubrik SLA domain assignments, completely eliminating the need to manage any RMAN scripts or catalogs. Automated Oracle Data Protection also provides value-add Rubrik benefits such as Automated Live Mount and Instant Recovery to bring near-zero recovery times to Oracle databases.

The Rubrik CDM 5.2 release for Oracle gives more power to Database Administrators (DBAs) to perform advanced tasks through features such as Advanced Cloning Options, Rollforward Recovery, Archive Log Retention, and expanded platform support:

- **Advanced Cloning Options:** Enables more flexibility to easily navigate through complex cloning scenarios for Live Mount and Clone operations.
- **Roll-forward Recovery:** Applies archive logs and brings the database forward in time to achieve the desired restore point.
- **Archive Log Retention:** Allows customers to delay the deletion of the archive logs or simply retain the logs on the host forever.
- **Expanded Platform Support:** Automated database recovery support for Exadata, ODA, and newer versions.

## CUSTOMER CHALLENGES

Oracle has long provided a high performing, scalable database solution for organizations to build their business applications and for this reason many organizations have chosen Oracle to run their most mission critical applications. As a result, it is imperative for stakeholders in the organization, especially, the database administrator (DBA) to make sure that the Oracle database is highly available and the data within is protected against media corruption, user induced errors, and noncompliance.

Although Oracle Recovery Manager (RMAN) is built into the Oracle database to provide data backup and recovery, managing a large number of databases using RMAN by itself can be challenging for DBAs. There are 4 key challenges DBAs face today.

### MAINTAINING AND MANAGING EXISTING BACKUPS

Oracle RMAN has beyond doubt been the tool of choice for DBAs when it comes to backup and recovery of their databases. DBAs may be comfortable to build impeccable scripts, but the problem lies in maintaining and managing those across multiple databases, adapting to changes in topology and ensuring compliance needs of the business. Thus, DBAs would prefer to offload database backups to a central backup system so that they can focus on running the database to meet the business application needs.

### BALANCING DATABASE PERFORMANCE AND PROTECTION

While data protection is essential, backup tasks may affect the performance of the database server, easily consuming one CPU core per RMAN channel. If full backups are run regularly, then multiple channels might be needed for high speed backups forcing the DBA to make the difficult tradeoff between backup performance and database performance.

### SERVING THE NEEDS OF SECONDARY USERS

A typical day of an Oracle DBAs life doesn't go by without a steady stream of requests from secondary users (developers, quality assurance teams, and analytics departments) who are looking to gain access to copies of production data for use cases such as testing, development and ETL (extract, transform, load) workflows. The DBA needs to juggle managing the needs of different departments with protecting mission critical databases serving the business.

### THE DIVIDE BETWEEN DBAS AND BACKUP ADMINISTRATORS

Backup administrators often handle the complete protection lifecycle of an organization's applications, from the backup and restore to the compliance and governance policies set forth by the business. While a DBA may be open to delegating backup tasks to the backup administrator, the responsibility still falls on the DBA to build and maintain RMAN scripts as the database environment changes. There is a high chance of human error due to multiple stakeholders being involved.

## KEY CAPABILITIES IN RUBRIK FOR ORACLE DATABASE

Before diving deeper into the Oracle Data Management solutions supported by Rubrik, this section will provide a brief overview of key capabilities we designed to eliminate the challenges described in the earlier section.

### AUTOMATED ORACLE DATA PROTECTION

Rubrik's Oracle Data Protection fully automates Oracle RMAN workflows after the Rubrik Backup Service (RBS) is installed on an Oracle host. All databases on an Oracle host are automatically discovered and displayed in Rubrik's web console. Customers can select the desired level of the object (Oracle Real Application Cluster, Oracle Host or a specific Oracle database) and assign a business SLA. The necessary RMAN scripts are generated during run time as per SLAs thereby taking the stress out of backup operations.

### TRUE INCREMENTAL FOREVER BACKUPS

Oracle's Incremental Merge feature coupled with Rubrik's revolutionary BLOB engine delivers true incremental forever backups at scale for Oracle database. If available, Rubrik will also take advantage of Oracle block change tracking (BCT) during backups so that it no longer needs to scan the entire database for incremental changes. Thus, after the first backup, the DBA never needs to worry about long backup windows negatively affecting performance of the database.

### RUBRIK LIVE MOUNT

Live Mount for Oracle databases delivers near-zero RTOs with instant recovery and live migration. In addition, DBAs can provide instant clones to developers, accelerating application development, testing and ETL (extract, transform, and load) workflows without any impact to production environments.

## INTRODUCTION TO RUBRIK CDM CONCEPTS

The following section will review various concepts and components available within Rubrik CDM assisting with Oracle Data Management.

### SLA DOMAIN POLICY

A Rubrik SLA Domain Policy is a declarative policy that captures the core objectives for backup and recovery. It eliminates the need to manually configure jobs, tasks, and other items for various object groups. SLA Domain Policies are a core part of the Rubrik architecture and extend across all data types, as shown below.

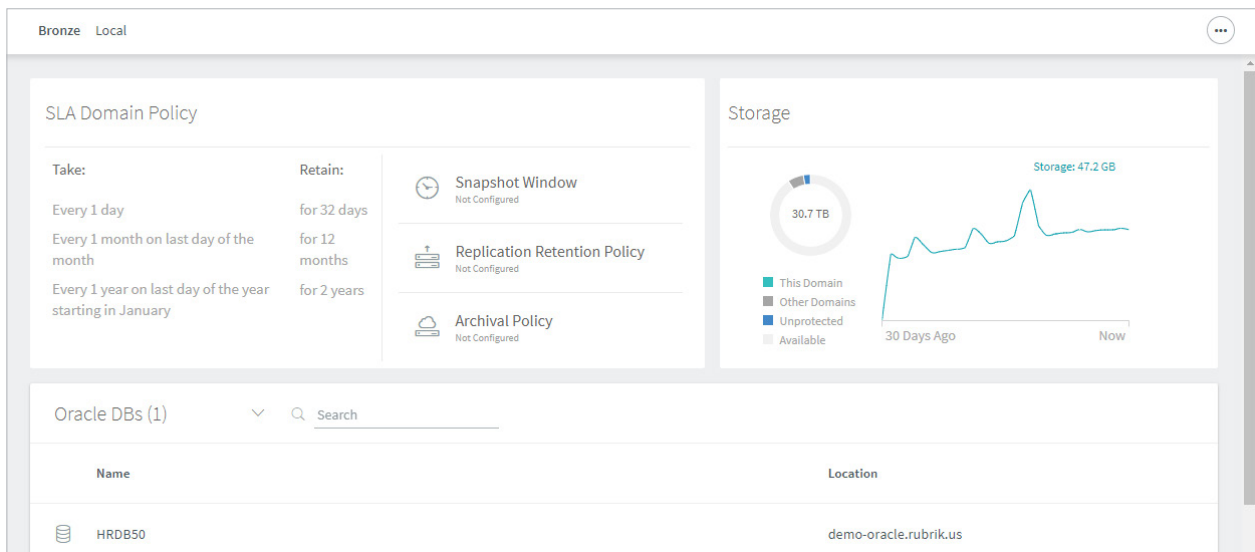

The pieces needed to configure an SLA Domain Policy for any object are:

- **Backup Frequency:** This is also known as the Recovery Point Objective (RPO). Simply put, how often are backups taken?
- **Availability Duration:** This is also known as retention. How long are backups retained?

### Service Level Agreement

Choose how often we take snapshots and the length of time we keep them.

Take Snapshots:	Keep Snapshots:
Every (Hours) 4	3 Days
Every (Days) 1	32 Days
Every (Weeks) 1 Friday	12 Weeks
Every (Months) On	Months
Every (Quarters) 1 Last day of the quarter	Begin Quarter in January 4 Quarters
Every (Years) 1 Last day of the year	Begin Year in January 7 Years

Local retention set to 7 years .

- **Archival Policy:** This policy determines the schedule for archiving the data, the retention period and archive target where the data is stored. Archive targets can be public cloud (AWS, Azure, or GCP) or on-premises (AWS S3 compatible object stores, NFS, or tape). If archives are maintained solely in the cloud (past 30 days for instance), the RTO is longer, as the data must be moved back to the Rubrik cluster.

### Archival Policy

Enable Archiving

Enable Instant Archive ⓘ

Archival Location  
Azure:se3demo

Move the slider to choose how long data is kept on the local Rubrik cluster before archiving.

66 days

Snapshots will be stored on the local Rubrik cluster for 66 days . Data will then be moved to your archival location and kept there for 6 years 299 days . Snapshots older than 7 years will no longer be available.

- **Replication Policy:** This relates to replicating the data to another site for disaster recovery (DR) purposes and also how long data should be kept at a DR site. Cost savings can be achieved by storing only a subset of data at the DR site.

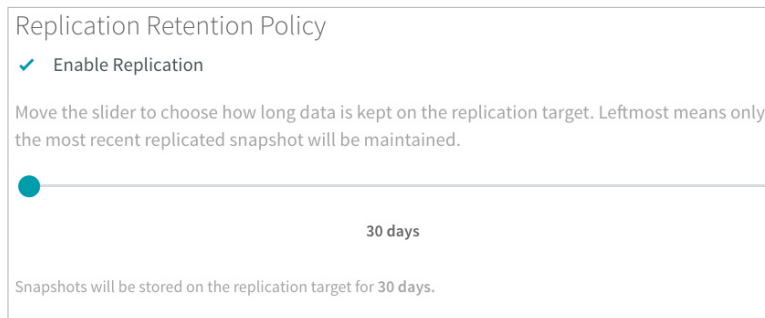

SLA Domains may be applied on the Oracle host, RAC Cluster, or per database. If placed at the host/RAC level, the subordinate databases will inherit the SLA Domain. Please see the Rubrik User Guide for a more thorough walkthrough of SLA Domain details.

## REPORTS

Rubrik provides a customizable visual analytics and reporting tool to meet the diverse reporting needs of Rubrik customers. Users can create a variety of reports by selecting specific attributes and measures, as well as by defining any relevant filters. Reports may be saved in the Report Gallery and sent out via email periodically. Collectively, these reports help customers optimize operations, enhance capacity and performance, plan for growth, and track compliance.

## ROLE-BASED ACCESS

Rubrik provides granular control along with integration into existing directory services (Active Directory) to make Rubrik a natural fit for multi-tenant environments. This is achieved by having a central organization with the ability to procure resources on behalf of tenant organizations. An organization is created and managed by a Global Admin who has the power to assign a subset of the privileges to an Organization or Org Admin.

There are multiple Rubrik resources managed within an organization such as SLA domains, fileset templates, archival and replication targets, and protected objects (virtual machines, SQL databases, Oracle databases, Windows / Linux hosts, NAS shares, and Managed Volumes). On top of that, you can use the Role-Based Access Control (RBAC) privileges to provide granular privileges.

As an example, a Database Administrator persona may be created with the ability to manage, protect, and recover selected Oracle databases. This can then be granularly scoped to include only specific databases.

# AUTOMATED ORACLE DATA MANAGEMENT WITH RUBRIK

## PROTECTING ORACLE DATABASES

The following will go through the protection and restoration processes of using Rubrik's Automated Oracle Data Protection in detail:

### SETUP

Rubrik supports Oracle versions 11gR2 and above for use with Automated Oracle Data Protection. Rubrik utilizes the Rubrik Backup Service (RBS), a non-intrusive agent which has been signed and configured to only communicate with its associated Rubrik cluster. RBS requires no reboot upon installation, and is able to auto-update without intervention.

RBS may be downloaded directly from within the Rubrik cluster UI by navigating to **Servers & Apps -> Oracle DBs**. The dialog presented provides download access for RBS in both rpm and deb packaging, as well as associated rpms for the supported AIX versions.

Add Hosts/Nodes

A Rubrik Backup Service must be installed on the hosts. Please enter comma separated IP address or hostnames to connect hosts. The existing Linux and Unix hosts will be pre-populated when you type the IP addresses or hostnames. Please also type a Oracle user in order to connect hosts. Compatible with:

Linux (rpm or deb)

- RHEL 6, 7
- CentOS 6, 7
- Oracle Linux 6, 7
- Ubuntu 14.04 LTS, 16.04 LTS, 17.04
- Debian Linux 8
- SUSE Linux 11, 12

AIX (6.1, 7.1 or 7.2)

IPs or Hostnames (Use commas to separate)

Oracle User (required if dba user is not "oracle")

Advanced Settings ▼

Cancel Add

It should be noted that after RBS has been installed, it is used only to automate database discovery and orchestrate various backup and restore workflows. The streaming of data is still handled natively by RMAN that writes data into a NFS file system pointing to the Rubrik cluster. For these reasons, an NFS Client and NFS Utilities must also be available on the Oracle host.

**Note:** If using Oracle Real Application Clusters (RAC), the RBS must be installed on all nodes within the cluster in order to provide automated discovery.



## AUTO DISCOVERY

RBS is required in order to perform automated discovery of Oracle hosts (standalone or Oracle RAC) and databases. Once RBS has been installed on the Oracle host, then it is added to the Rubrik cluster. Thereafter, the databases and associated database metadata, the list of running instances and tablespaces are auto discovered. In order for databases to be automatically discovered they must be in an **OPEN** or **MOUNTED** state.

**Note:** If no databases happen to exist on the Oracle host, an empty `/etc/oratab` file with the proper permissions must be created in order to add the host to the Rubrik cluster.

The **Hosts/Clusters** view organizes the Oracle inventory grouped by either standalone Oracle hosts or RAC clusters. Selecting the name of either a host or cluster will subsequently provide further detail around the selected object.

Name	Nodes	Databases	SLA Domain	RBS Status
aix6-lpar23	1	0	No SLA	Connected
aix6-lpar24	1	1	No SLA	Connected
rk-cluster	1	0	No SLA	Disconnected
rk-demo.localdomain	1	1	Do Not Protect	Connected
rk-demo2.localdomain	1	0	Do Not Protect	Connected
source-cluster	2	2	No SLA	Connected
source1.localdomain	1	1	No SLA	Connected
src1perf	1	0	No SLA	Connected
target-cluster	1	1	No SLA	Connected
target2.localdomain	1	0	No SLA	Connected
tgt1perf	1	1	No SLA	Connected

The **All DBs** view displays a complete list of every Oracle database known to the Rubrik cluster, along with their corresponding number of instances and tablespaces. Selecting the name of a database will display the respective database overview page.

Name	Cluster/Host	Log Backup	Instances	Tablespaces	SLA Domain	Assignment
_mgmtdb	source1.localdomain	--	1	8	No SLA	Unassigned
_mgmtdb	aix6-lpar24	--	1	8	No SLA	Unassigned
aixdb	tgt1perf	--	1	13	Do Not Protect	Direct
demo	rk-demo.localdomain	15 mins	1	5	Gold	Direct
hqdb	target-cluster	--	1	8	No SLA	Unassigned
hqdb	source-cluster	--	2	8	Do Not Protect	Direct
rk	source-cluster	--	2	6	No SLA	Unassigned

## SLA DOMAIN ASSIGNMENT

SLA Domain Policies can be applied at the Oracle host/RAC Cluster or database level.

**Note:** SLA Domains are inherited from their parent objects. For instance, if an SLA domain is assigned at the Oracle host level, all subsequent databases on that host will receive the same SLA domain. The inherited policy may be overridden by assigning another policy directly on one of the child items.

Selecting either a host, cluster, or database and selecting **Manage Protection** will allow the selection of an SLA Domain policy.

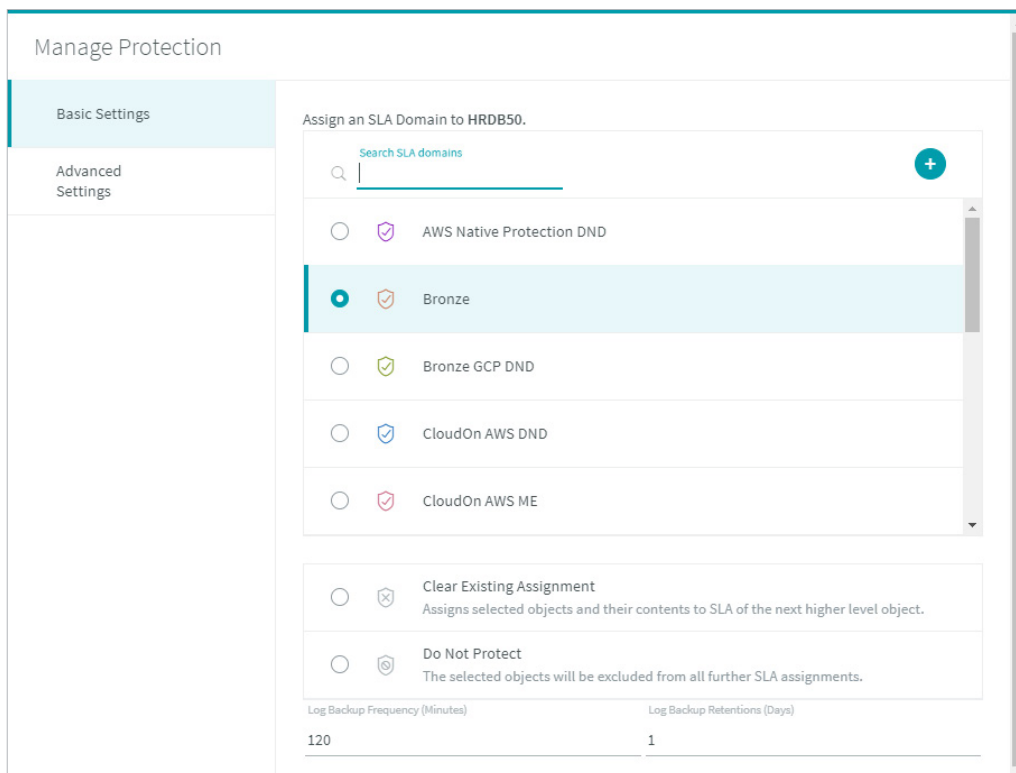

**Note:** Since Rubrik uses both full database and archive logs to perform database restorations, the Oracle archive log retention is required before an SLA Domain can be applied. Without an archive log backup schedule, the database will remain greyed out within the Rubrik UI.

The **Advanced Settings** dialog allow setting:

1. **Number of RMAN channels** used during the backup process so that the Rubrik cluster can balance channels across all of the nodes of the RAC cluster. It is recommended that the number be lower than the number of cores on the Oracle host or the number of nodes in the Rubrik cluster.
2. **RAC Nodes Priority** guides Rubrik to use the highest ordered node to process a backup and if a node is unavailable, then the next node in the list, and so on, and so forth. This allows DBAs to dedicate certain nodes only for backups so that other nodes, can serve production data without any impact during backup events.

### Manage Protection

Basic Settings

Advanced Settings

Number of RMAN Channels

4

---

Nodes

You can specify an ordered list of nodes to take the backup from.

	Node	
1	10.1.14.40	↑ ↓
2	10.1.14.41	↑ ↓

Cancel
Submit

## ORACLE BACKUP WORKFLOW

Once all prerequisites are met, Rubrik will proceed with the backup processes. The Rubrik cluster protects an Oracle database by running two separate jobs i.e. Database backups and Archive Log backups. These processes run at different times. Rubrik handles the scheduling and maintenance of all their associated tasks.

**Database backups** are governed by the backup frequencies and retention configured within the assigned SLA Domain and are created using RMANs incremental merge setting. They only transfer the incrementally changed data, merging it with the previous restore point to create a conceptual full backup for the new restore point.

**Archive log backups** are governed by the frequencies and retention configured within the Log backup settings of the applied SLA Domain. Unlike database backups, each log backup is completely independent from the previous backup as there is no concept of incremental when parsing Archive Logs. Once the RMAN log backup has been completed, the archive logs are then deleted from the source host.

Rubrik CDM 5.2 now offers more control over archive Logs after successful log backups. Customers can now choose to delay the deletion of the archive logs or simply retain the logs on the host forever. This provides customers the flexibility to use the archive logs for other use cases while maintaining ongoing backups.

Rubrik will automatically manage the archive logs, associating them with the respective database backups so that DBAs do not need to manually manage the backup processes.

## RESTORING ORACLE DATABASES WITH RUBRIK

DBAs often need to recover to an exact point in time. Simply restoring a daily backup is not sufficient when dealing with high-transactional, constantly changing databases, and can result in lost productivity and more drastic, lost data. This is why Rubrik parses archive log backups alongside the full database backups, allowing for DBAs and backup administrators to simply select nearly any point in time during the backup retention period as shown below.

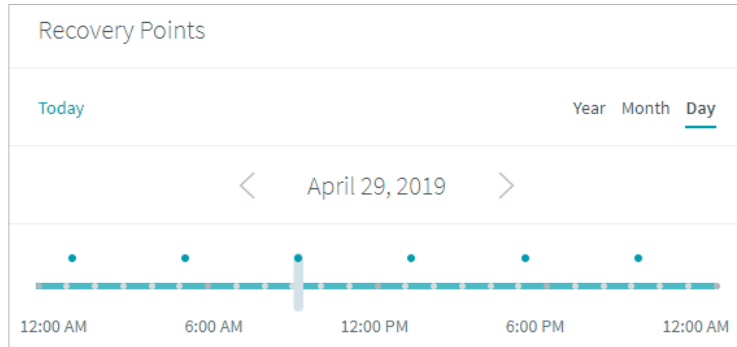

The process of restoring an Oracle database to any point in time is accomplished by first restoring the closest preceding full database snapshot before the selected recovery point, and then applying the appropriate archive logs to essentially move that database forward until the recovery point is reached. As shown below, to support the selected restore point, first the database backup at S2 will be restored, and then archive logs 4, 5, and 6 will be applied. This process is completely orchestrated by Rubrik.

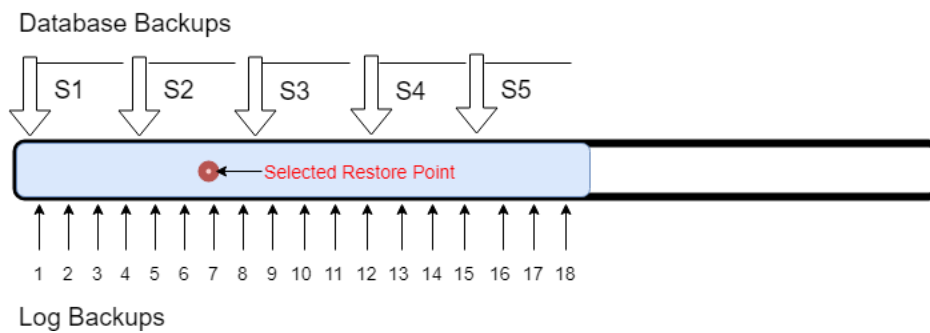

Once a point in time for recovery has been selected with Rubrik, the ellipsis menu can be used to display its associated recovery methods.

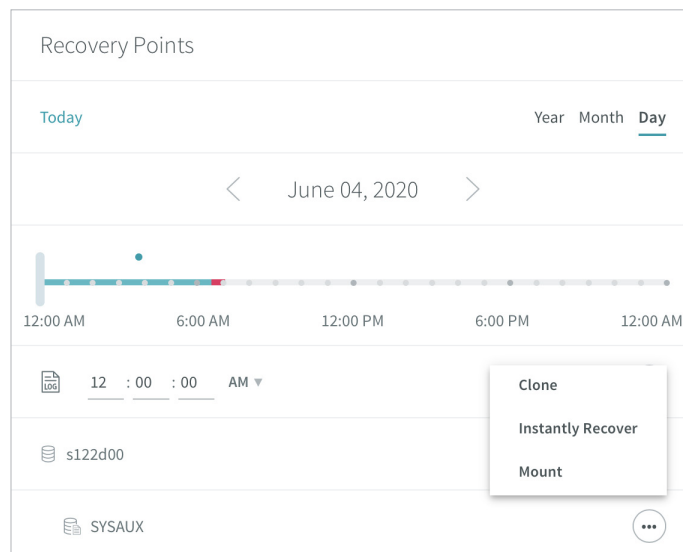

There are four recovery options for Oracle databases: **Clone**, **Instant Recovery**, **Live Mount**, and **Recover Production**.

## CLONE

The **Clone** option (previously known as **Export**) within Rubrik allows for an entire Oracle database or tablespaces to be restored to a target host. The datafiles, log files and other parameter files are copied from the Rubrik cluster to the target to perform database recovery.

**Note:** Export was renamed to Clone to avoid confusion with the existing Oracle EXP/IMP utility.

In order to perform an Clone with Rubrik the following prerequisites must be met:

- The target Oracle RAC, RAC node or standalone host must have RBS installed and must be registered within the Rubrik cluster
- The source and target must have the same `$ORACLE_HOME` and Oracle versions.
- To support RAC clone, the oratab must have the ASM grid configuration for the RAC.
- There must not be an instance on the target with the same database SID.
- Enough resources (capacity, memory, compute) must be available on the target host.

Cloning can be performed in two different modes: **Automated** and **DBA Managed**.

### AUTOMATED CLONE

During an automated clone Rubrik will completely restore the Oracle database files, and recover the database. On top of simply moving the data, Rubrik will also create and start up the database instances, updating the local `oratab` file. Since Automated Clone doesn't support restorations to the same Oracle host, DBA Managed Clone can be utilized.

## Automated Export

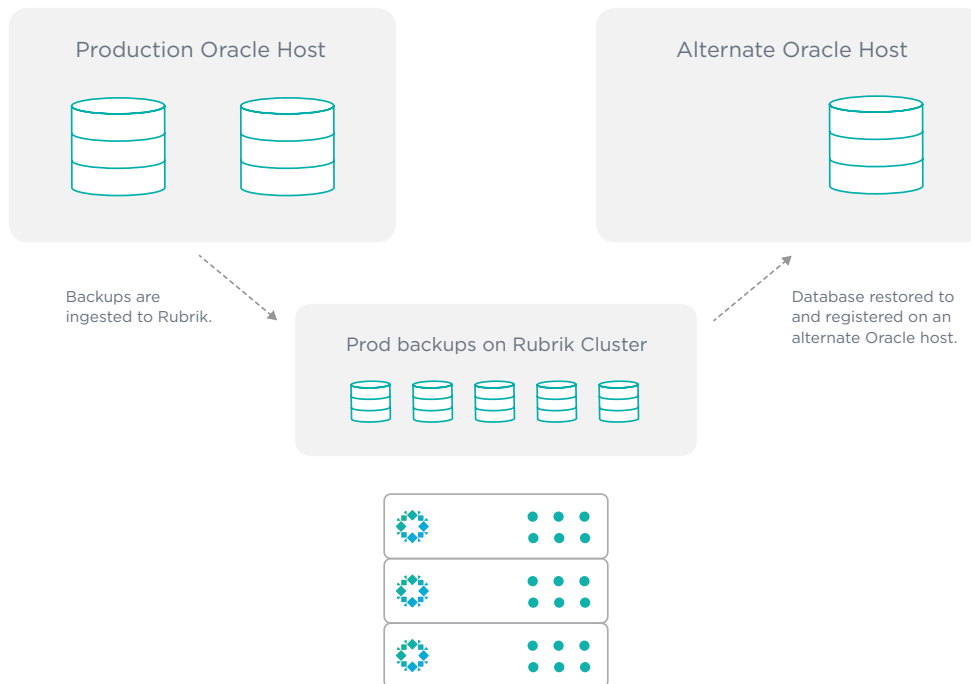

## DBA MANAGED CLONE

In a DBA Managed Clone, instead of restoring the database to an Oracle host, Rubrik copies the database files to a specified location and exposes the RMAN recovery scripts. DBAs have flexibility to create custom RMAN scripts and perform both alternate and same host recoveries.

## DBA Managed Export

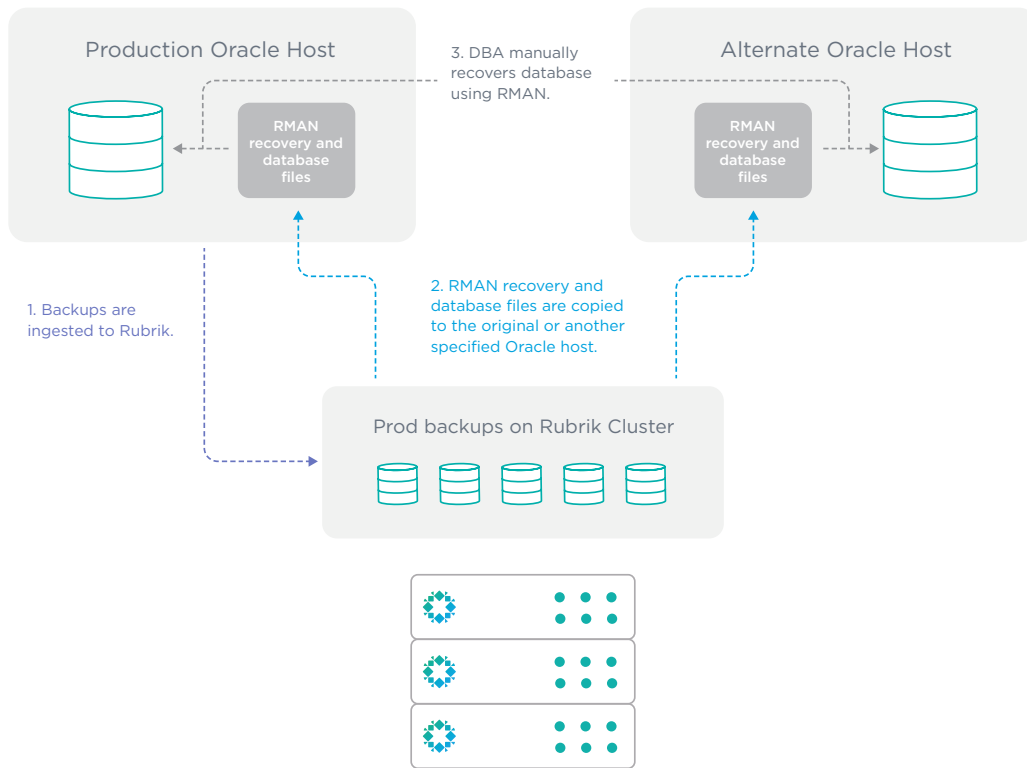

## TABLESPACE CLONES

Rubrik can also clone individual tablespaces back to the original Oracle host. Tablespaces bring benefits such as quotas, performance, and capacity allocation. DBAs can now restore only certain portions of the database without having to take the complete database offline. Additionally, `SYSAUX`, `SYSTEM`, and `UNDOTB` tablespaces cannot be restored and the targeted tablespace must be manually dropped before recovery.

**Note:** Customers should take an On-Demand database backup if they add or drop tablespaces. This will ensure immediate availability of changes for recovery operations.

## INSTANT RECOVERY

While Clone performs a traditional restore, Instant Recovery does this without copying all of the associated data. This allows faster recovery and a near instantaneous RTO after a complete database failure irrespective of the database size.

**Note:** Instant Recovery requires DBAs to manually drop the original database before proceeding. Once dropped, a host refresh will need to be initiated.

### Oracle Instant Recovery

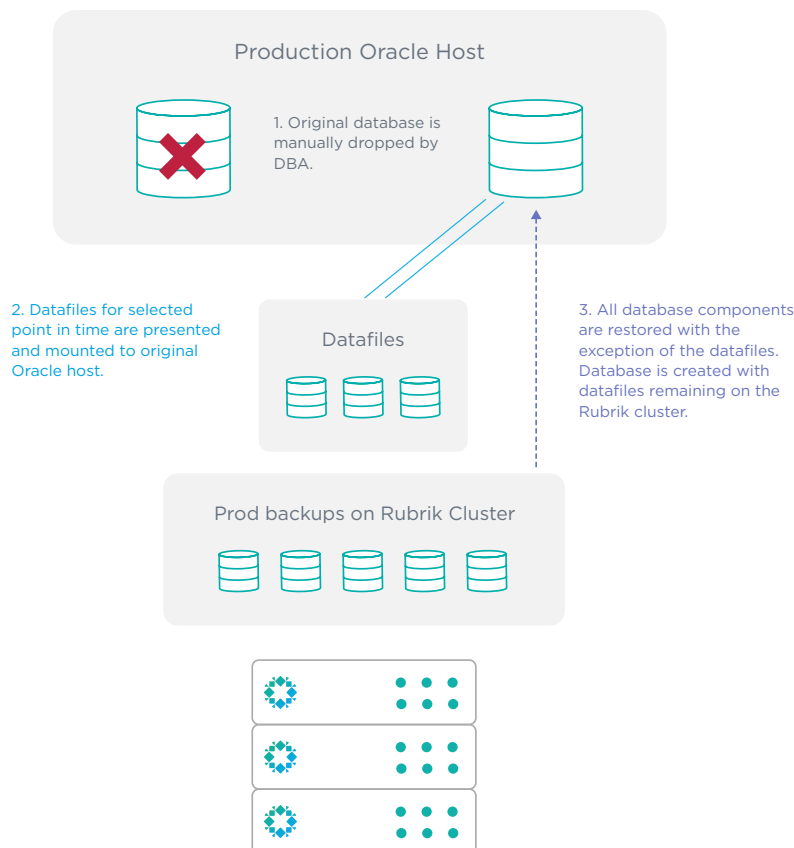

With Instant Recovery, the end goal is to remove the storage dependency on the Rubrik cluster and migrate all data back to the Oracle storage. DBAs can use the native `'ALTER DATABASE MOVE DATAFILE'` command, included in Oracle 12c and higher, to migrate the datafiles **online** from the Rubrik cluster to any storage location. For Oracle version before 12c, the database will need to be taken offline in order to process the migration.

Rubrik CDM 5.2 introduces Advanced Cloning Options (ACO) for DBAs to accommodate cloning scenarios involving dissimilar Oracle Homes/ ASM disk groups between source and target database. DBAs can also customize memory parameters (SGA, PGA, Huge pages), control database file destinations, and restore SPFILE to a custom location of their choice.

## LIVE MOUNT

Live Mount recovery is similar to Instant Recovery, however instead of creating the database on the original Oracle host, any registered Oracle host may be utilized. Live Mount point-in-time copies enable many different use-cases such as testing and development, quality assurance, ETL, and even granular item-level recovery using Oracle data pump.

### Oracle Live Mount

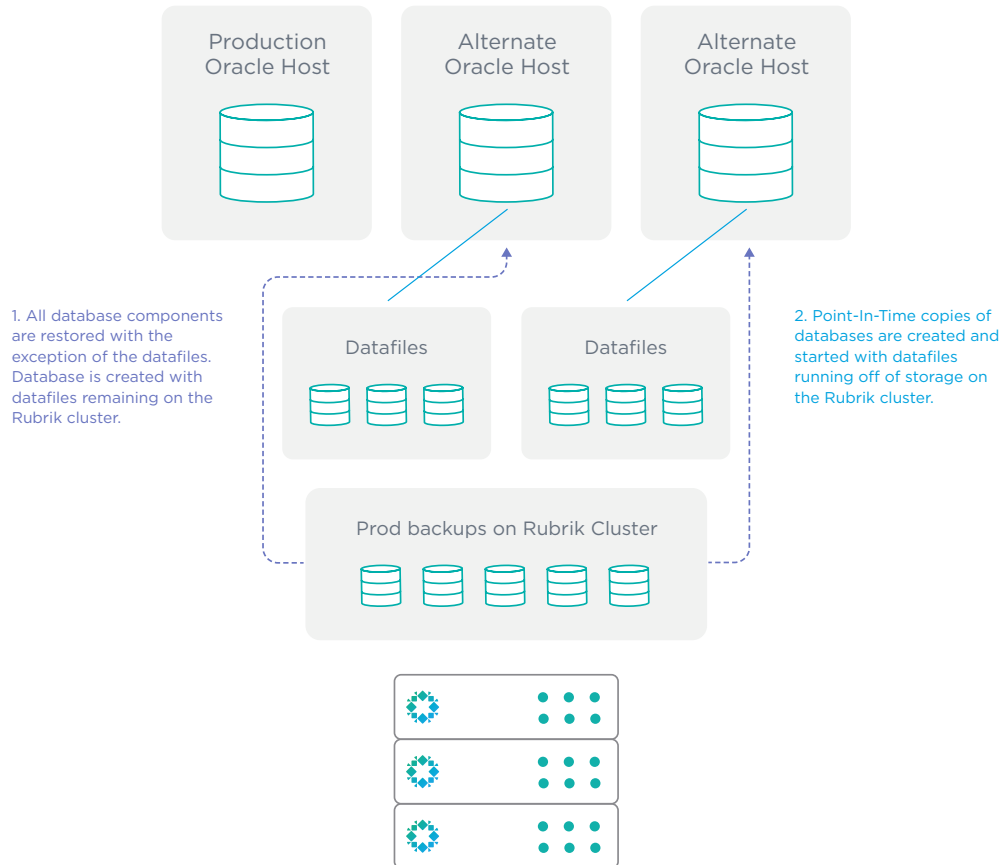

Like Instant Recovery, only non datafile components are restored to an Oracle host, meaning these duplicate point-in-time copies can be created in a nearly instantaneous fashion. Upon completion of testing, the database can be unmounted within Rubrik. During an unmount operation any changed data is discarded and the space is reclaimed on the Rubrik cluster.



## RECOVER PRODUCTION

Recover Production automates this production recovery scenario with a single click and minimizes the stress on DBAs in the event of a production database failure. The complete database is restored directly to the original host from the backups hosted on the Rubrik Cluster, and then the database is recovered to the latest consistent backup. This is usually the rarest of scenarios when there has been a complete database failure. Like Instant Recovery, it requires the target database to be dropped beforehand.

### Recover Production

Caution: This will overwrite your production database and delete existing archive redo logs on the host. If you continue, the latest database recovery point (Mar 24, 2019 12:37:08 PM) for this database available on Rubrik will be restored to your host and database recovery will be performed. Do you want to continue?

Apply Logs From Host

- /placeholder/placeholder/temp1
- /placeholder/placeholder/temp2
- /placeholder/placeholder/temp3
- Customized Path

Moreover, as part of Rubrik CDM 5.2, we have introduced a new feature called Rollforward Recovery, which allows DBAs to customize the recovery to the desired point in time by applying archive logs on the Oracle host. DBAs can either point to the default location for archive logs or a custom location of their choice on the Oracle host.

## CONCLUSION

Rubrik provides both speed and simplicity for Oracle Data Management. DBAs and backup administrators can offload RMAN catalog management and leverage automated Oracle protection to take advantage of near-zero RTO capabilities such as Rubrik Instant Recovery and Rubrik Live Mount. While robust and full-featured, Rubrik's support for Oracle Data Management extends the Rubrik focus on simplicity, understanding customers true operational requirements, and solves a number of data protection challenges.



### Global HQ

1001 Page Mill Rd., Building 2  
Palo Alto, CA 94304  
United States

1-844-4RUBRIK  
inquiries@rubrik.com  
[www.rubrik.com](http://www.rubrik.com)

Rubrik, the Multi-Cloud Data Control™ Company, enables enterprises to maximize value from data that is increasingly fragmented across data centers and clouds. Rubrik delivers a single, policy-driven platform for data recovery, governance, compliance, and cloud mobility. For more information, visit [www.rubrik.com](http://www.rubrik.com) and follow @rubrikInc on Twitter. © 2020 Rubrik. Rubrik is a registered trademark of Rubrik, Inc. Other marks may be trademarks of their respective owners.